



ENERDRIVE



DOMETIC

THE **ADVENTURER**

Installation Guide

K-ADVENTURER-02 and K-ADVENTURER-03



Congratulations on the purchase of The Adventurer power system from Enerdrive. This all-in-one system was designed for those who want the best charging, power supply and monitoring package in one neat easy to install package. Your system includes the following individual products:

- Enerdrive DC2DC+ DC Battery Charger
- Enerdrive ePOWER 12V 40A AC Battery Charger
- Enerdrive ePOWER 2000W Inverter with AC Transfer Switch and Safety Switch
- Simarine Pico Monitor with SC301 Shunt and additional SCQ50 shunt (-03 version only)

The following guide is for the installation of the pre-assembled power system, for specifics on each product please refer to the individual product manuals supplied or online at www.enerdrive.com.au.

- **Mounting**

- Choose the location of The Adventurer with focus on keeping the battery as close as possible (less than 1.5m is ideal) to the system. If the distance from the battery to The Adventurer is greater than 1.5m larger diameter cable than the recommended 70mm² will be required.
- Consideration must be given to avoid moisture and excessive dust.
- Firmly fasten The Adventurer by fastening through the black plastic backing panel of The Adventurer to your vehicle using suitable fasteners (not supplied). Ensure the structure you are securing The Adventurer to is rigid and can support the weight of the power system.

Caution: Ensure any debris from the mounting process is thoroughly removed to prevent damage to equipment or wiring.

Caution: Ensure that there is adequate spacing for wiring and be sure to check no wiring is in the path of fasteners when mounting the power system.

Connecting Loads (Appliances)

- Connect the positive wire from your lights, pumps, and other accessories to the system by connecting to either one of the four switches using insulated female spade crimps or directly to the appropriately labelled circuit breaker using 4mm ring terminals. If wiring through a switch you will need to connect a positive wire (same size as the wiring to your lights, pump or accessory and rated to the circuit breaker value) from the appropriately labelled circuit breaker to your desired switch. Note the supply is connected to the top terminal whilst the load is connected to the bottom terminal.

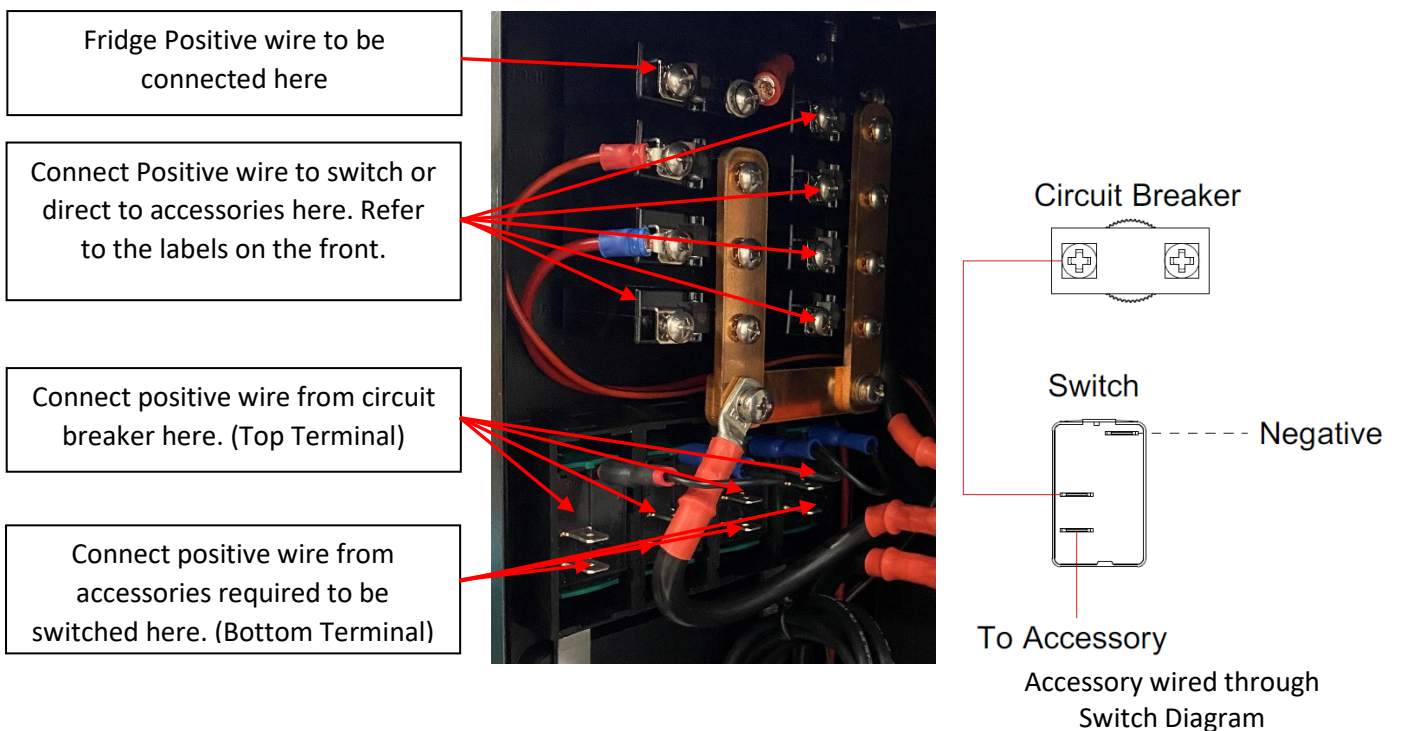

Note: Ensure current ratings of the accessories do not exceed the circuit breaker ratings or the switches, which are rated at 20A each switch. If larger loads are to be switched use a relay.

- Connect the negative wire from your lights, pumps, and other accessories to the system by connecting directly to the negative bus bar using 4mm ring terminals. If you have a larger load circuit (over 30 amps) we recommend to connect the negative directly to the Main negative Bar

Connect negative wire from accessories to this busbar.

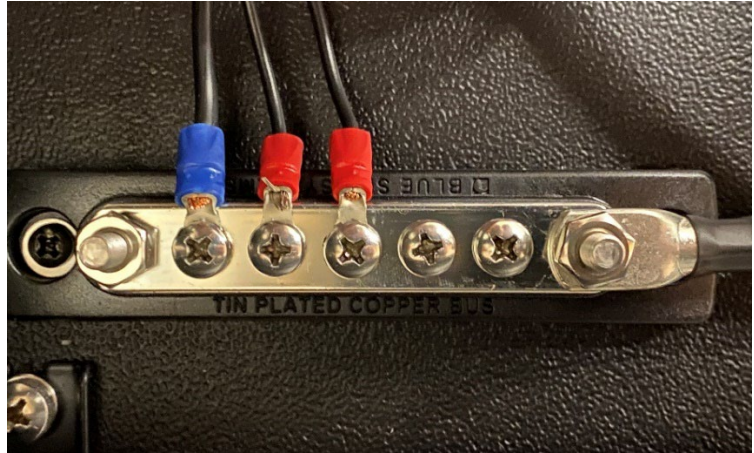

Note: No negative connections are to be direct to the battery or on the battery side of the shunt as this will result in incorrect reading on the Simarine system.

Solar Connection

- If you are fitting either fixed solar panels or portable solar panels via an Anderson plug, connect the solar wiring directly to the DC2DC+ as the MPPT regulator is inbuilt. Cabling should be sized to the rating of solar installed but as a minimum 4mm² cable is to be used with 6mm ring terminals connecting to the solar terminals on the DC2DC. Ensure the panels are disconnected or covered from the sun during connection to the DC2DC.

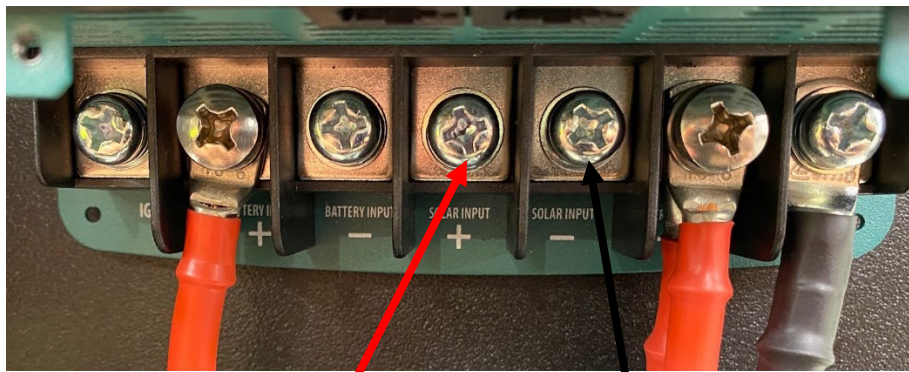

Solar Positive

Solar Negative

Connection to Main (Start) Battery

- Connect the Battery Input terminals of your DC2DC+ to your vehicles main/start battery. A 70A midi fuse located as close as possible to the main/start battery is required. Refer below cable sizing chart.

DC2DC Connection Inputs	Require Length & Battery Cable Size		
DC2DC set to 50A Output	2 Meters to 5 Meters (2)	Up to 10 Meters (2)	Greater than 10 Meters
From Alternator Battery	16-25mm ² @ 12vdc / 8-10mm ² @ 24vdc	35-50mm ² @ 12vdc / 16-25mm ² @ 24vdc	Not Recommended
Primary Battery Connection (2)	16-25mm ²	Not Recommended	Not Recommended



Vehicle Positive Vehicle Negative

Note: Refer to DC2DC manual for information on wiring for vehicles with smart alternators.

Connection to Auxiliary Battery

- Connect your auxiliary (main house battery) battery negative cable, which is to be a minimum of 70mm² (00AWG), to the Simarine shunt stud using a 10mm ring terminal, the one with no cable connected.

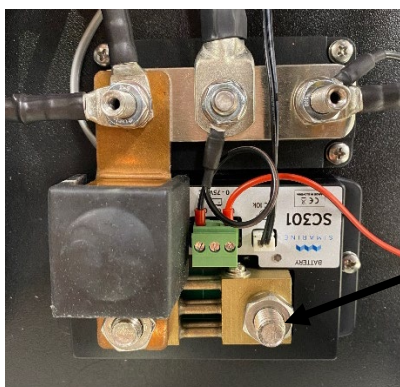

Connect main negative cable from auxiliary battery here.

- Connect your auxiliary battery positive cable, which is to be 70mm² (00AWG), to the back of the copper bus bar using an 8mm ring terminal.



Connect main positive cable from auxiliary battery here.

- Finally connect the positive cable to the battery followed by the negative cable to the battery using correctly sized ring terminals, in the case of an Enerdrive Lithium battery use 8mm ring terminals.

Note: No other connections are to be direct to the battery as this will result in incorrect reading on the Simarine system.

Note: Due to the Inverter requiring grounding it is important to ensure that there is an electrical connection from the inverter ground terminal to the vehicle's chassis, this can be made through the main DC cable connections.

Temperature Sensor

- The supplied temperature sensor, plugged into the Simarine SC301 shunt, can be located in your desired location such as canopy space, fridge or freezer.

Note: Do not cut or extend the temperature sense cable as this may result in inaccurate readings.

Inverter AC Wiring

Caution: AC wiring is only to be performed by a licensed electrician, please check your local state or territories requirements.

Simarine Settings

Your Simarine will come with basic set up completed, however if you wish to add or customise any settings please refer to the supplied Simarine manual.



Adventurer - ePRO Wiring Diagram

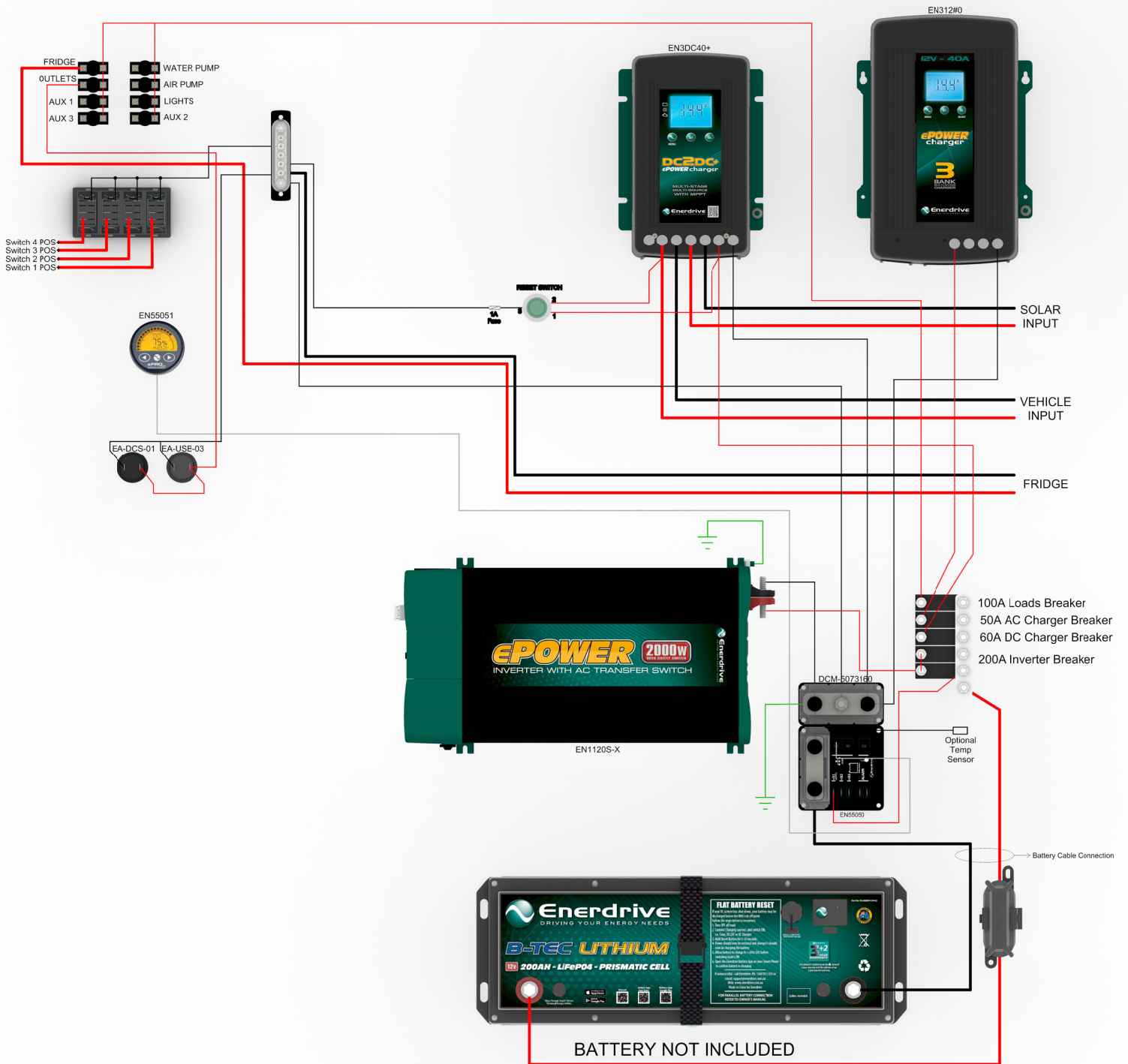

ENERDRIVE POSITIVE WIRING
 ENERDRIVE NEGATIVE WIRING
 INSTALLER POSITIVE WIRING
 INSTALLER NEGATIVE WIRING

This wiring diagram is only a representation on how the wiring is done and may not fully reflect exactly how your system is wired. Circuit breakers are shown in rear view format.



Adventurer - Simarine Wiring Diagram

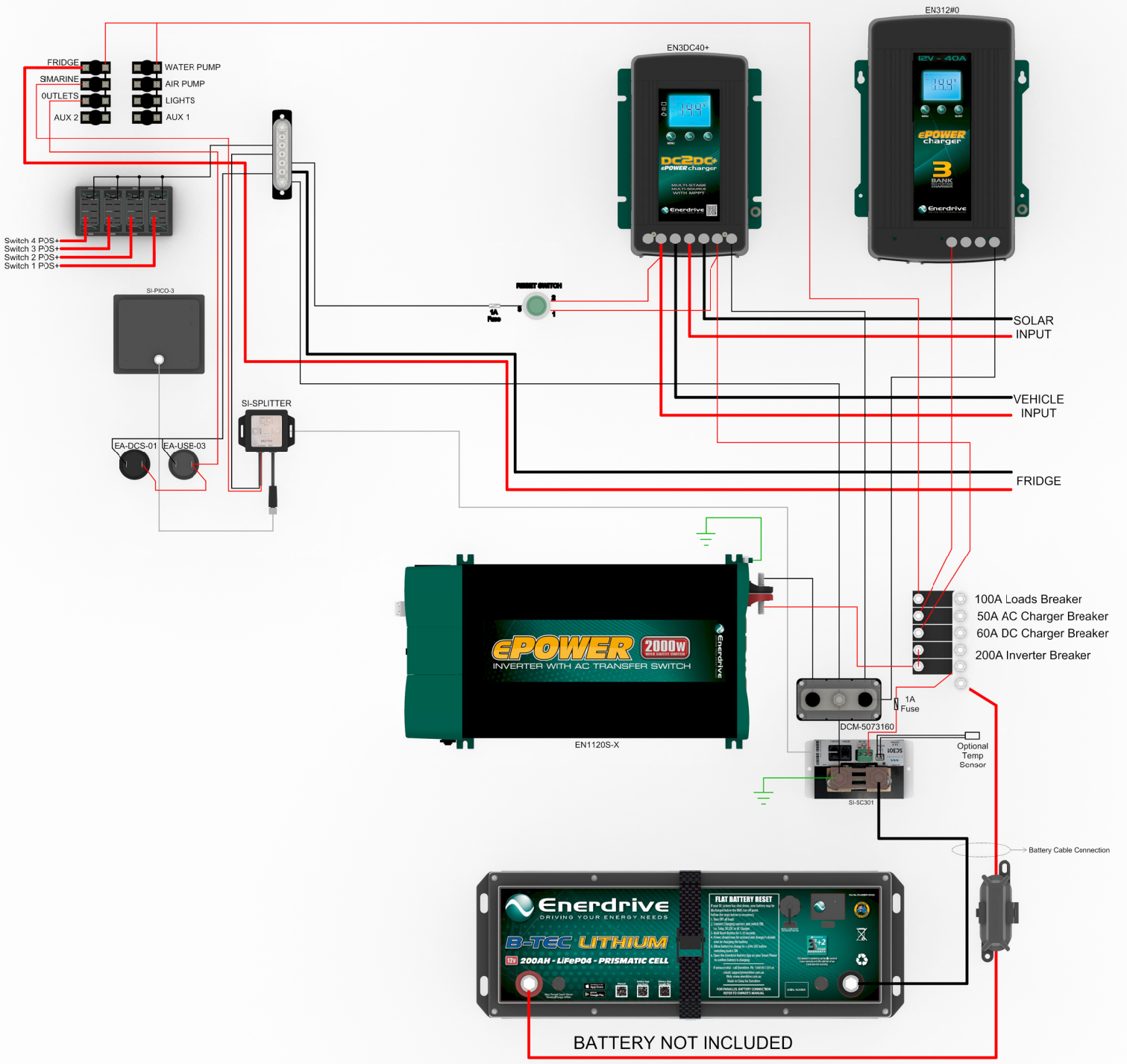

- ENERDRIVE POSITIVE WIRING
- ENERDRIVE NEGATIVE WIRING
- INSTALLER POSITIVE WIRING
- INSTALLER NEGATIVE WIRING

This wiring diagram is only a representation on how the wiring is done and does not fully reflect exactly how your system is wired.
Circuit breakers are shown in rear view format.



Adventurer - Simarine-SCQ50 Wiring Diagram

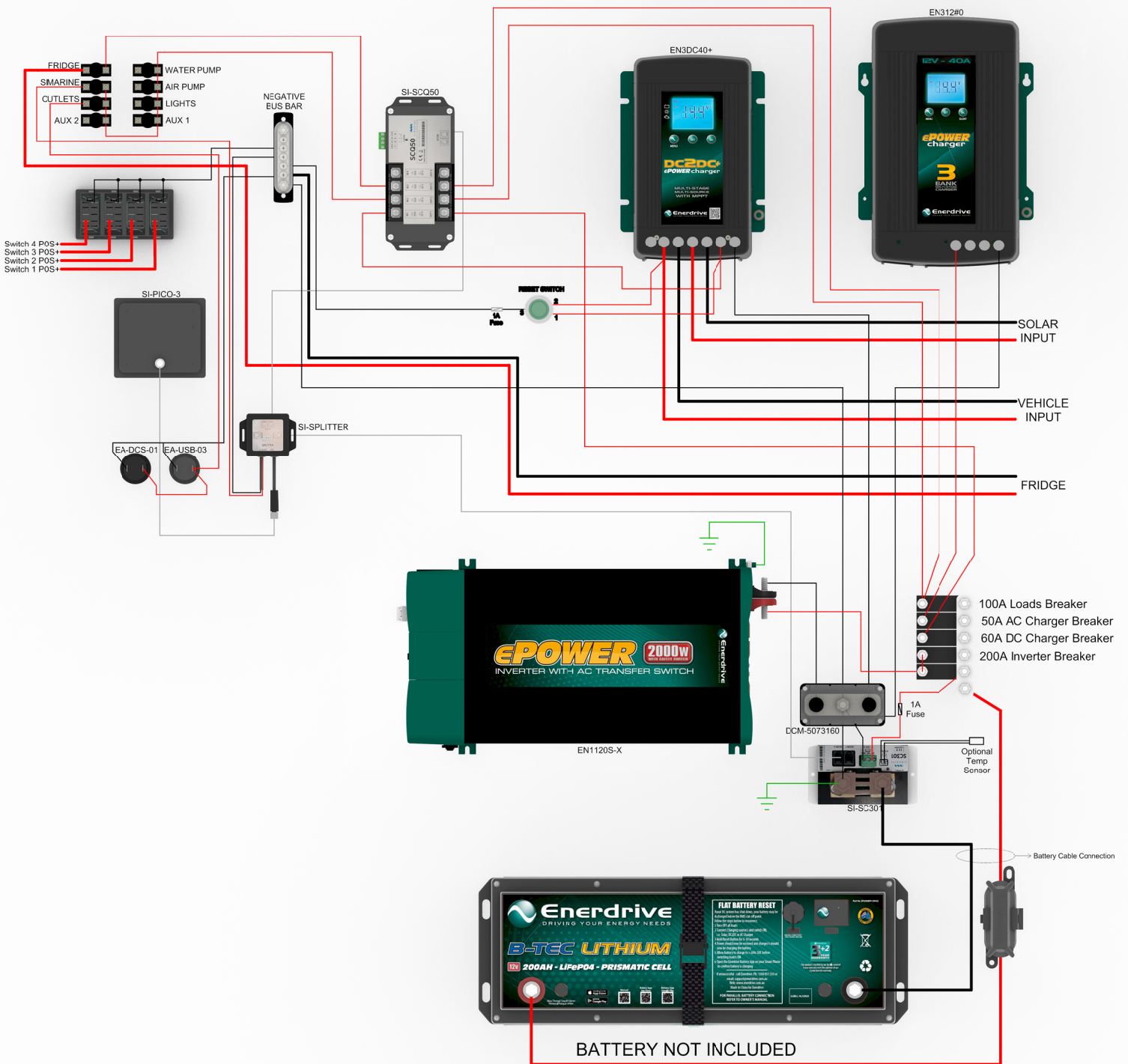

- ENERDRIVE POSITIVE WIRING
- ENERDRIVE NEGATIVE WIRING
- INSTALLER POSITIVE WIRING
- INSTALLER NEGATIVE WIRING

This wiring diagram is only a representation on how the wiring is done and does not fully reflect exactly how your system is wired.
Circuit breakers are shown in rear view format.

Specifications:

DC Charger

Output Current Maximum: 40~50A

Solar Input Voltage: 14.5-45VOC

Solar Wattage Maximum: $\leq 23V$ Input, 500W (600W allowable), $\geq 37.5V-45V$ Input, 750W (800W allowable)

AC Charger

Output Current Maximum: 40A

Inverter

AC Output: 230V 50Hz

AC Output Power: 2000W

AC Output Current: 8.7A

General

Dimensions: 630L x 155W x 665H

Weight: 18Kg



5 Year Warranty

In the unlikely event that a technical issue arises with an Enerdrive product, customers are encouraged to initially contact the Enerdrive Support Team on 1300 851 535 or support@enerdrive.com.au for immediate and efficient expertise and first class product support.

Important Note: Consumer Protections

If you have purchased your product in Australia, you should be aware that:

This warranty is provided in addition to other rights and remedies held by a consumer at law. Our goods come with guarantees that cannot be excluded under the Australian Consumer Law. You are entitled to a replacement or refund for a major failure and for compensation for any other reasonably foreseeable loss or damage. You are also entitled to have the goods repaired or replaced if the goods fail to be of acceptable quality and the failure does not amount to a major failure.

Enerdrive warrants that its Products will be free from defects in materials and workmanship (subject to limits, and in normal conditions, as described in the complete Enerdrive Warranty Policy) for up to 5 years from the date of purchase.

For full terms, conditions and claim process, refer to the Enerdrive website.
<https://enerdrive.com.au/warranty/>

ENERDRIVE PTY LTD

P.O. Box 9159, Wynnum Plaza, Queensland, Australia 4178

Ph: 1300 851 535 / Fax: 07 3390 6911

Email: support@enerdrive.com.au

Web: www.enerdrive.com.au