



BUILD-IN COOKING HOB
FOR USE WITH UNIVERSAL LPG ONLY

TOPLINE INSET GLASS HOBS



S-HB164XXZ



S-HB169XXZ

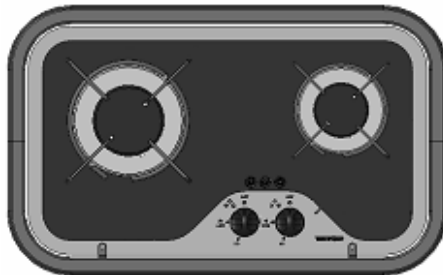

S-HB162XXZ

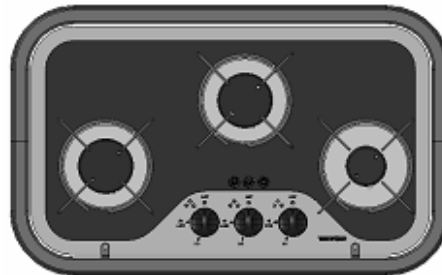

S-HB167XXZ

USER AND INSTALLATION INSTRUCTIONS

Please read thoroughly and keep for future

- This appliance must be installed by an authorised person.
 - Only use this appliance in a well ventilated area

FOR USE IN AUSTRALIA

THETFORD AUSTRALIA PTY LTD
130-132 Freight Drive Somerton VIC 3062
TEL: 03 9358 0700 FAX: 03 9357 7060

TOPLINE - INSET HOBS

Models with Sabaf Control Taps and Burners











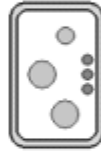

MODEL CODE	SERIES 162	SERIES 164	SERIES 167	SERIES 169
	S-HB162XXZ	S-HB164XXZ	S-HB167XXZ	S-HB169XXZ
				
	Σ MJ	Σ MJ	Σ MJ	Σ MJ
				
				
				
	14.9	19.4	15.6	20.8
				
	H (mm)	H (mm)	H (mm)	H (mm)
	105	105	105	105
	W (mm)	W (mm)	W (mm)	W (mm)
	600	564	600	546
	D (mm)	D (mm)	D (mm)	D (mm)
	370	542	370	482
	 10kg	 12kg	 10.5kg	 11kg
	From Top = 80mm From front = 300mm	From Top = 80mm From front = 275mm	From Top = 80mm From front = 300mm	From Top = 80mm From front = 275mm

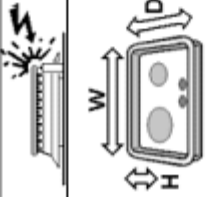
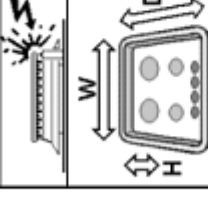
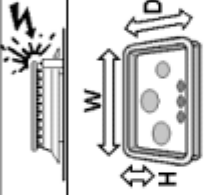
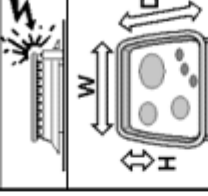
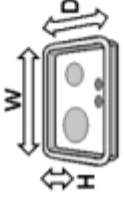
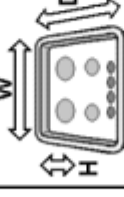
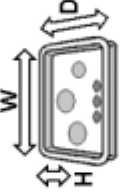
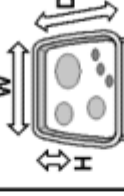
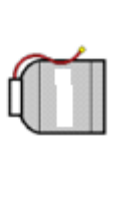
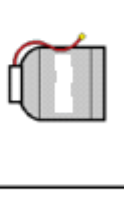
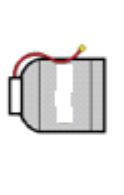
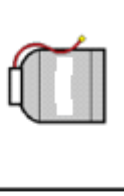
FIG. 1 CONTROL POSITIONS

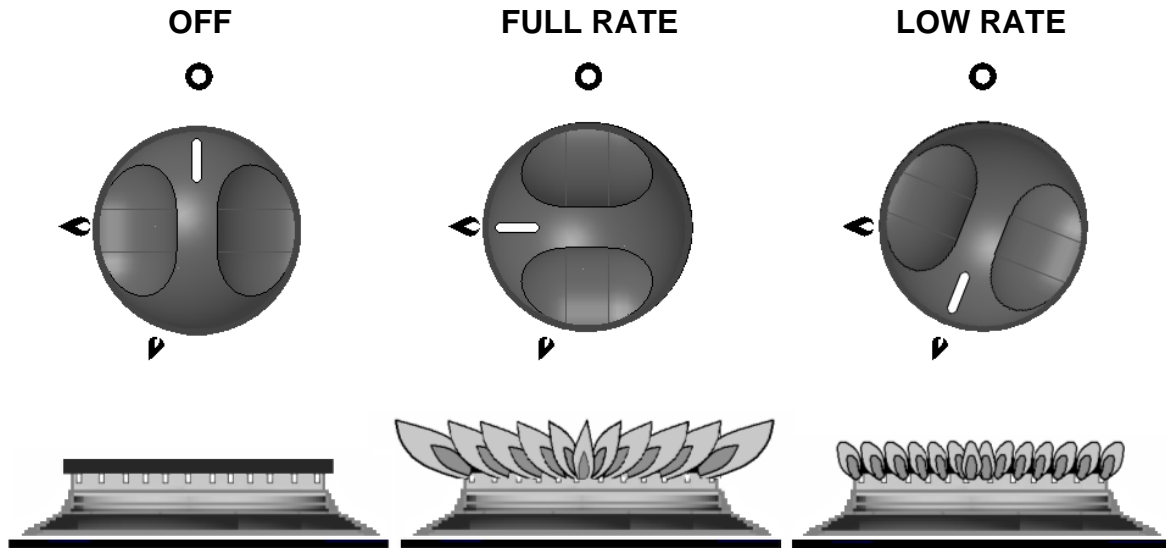
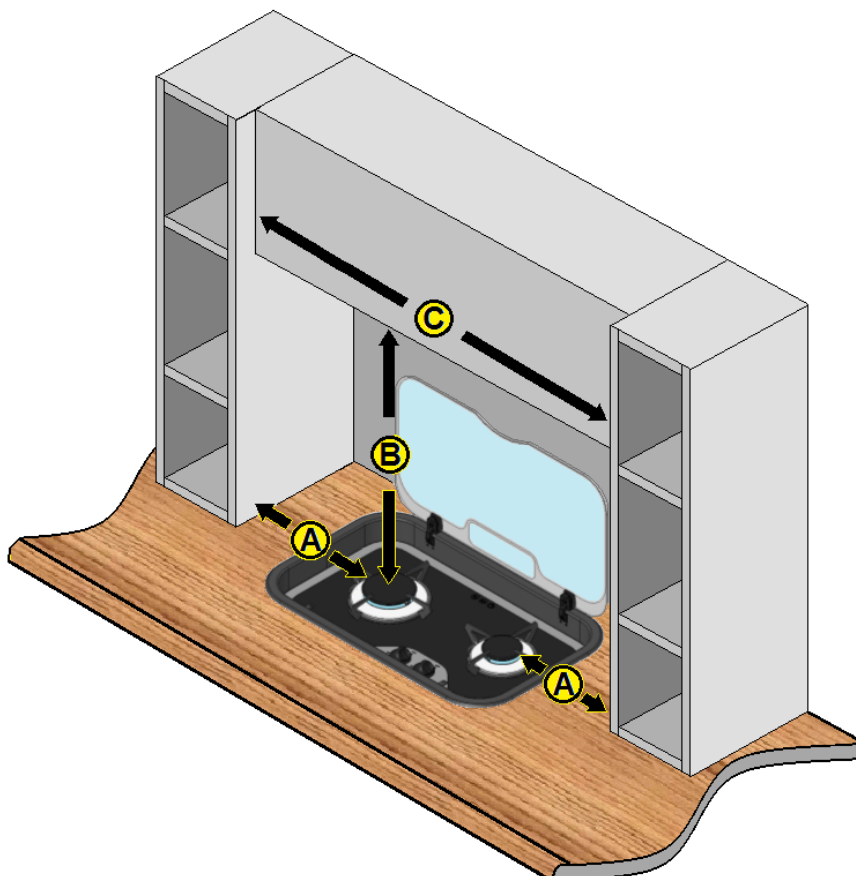
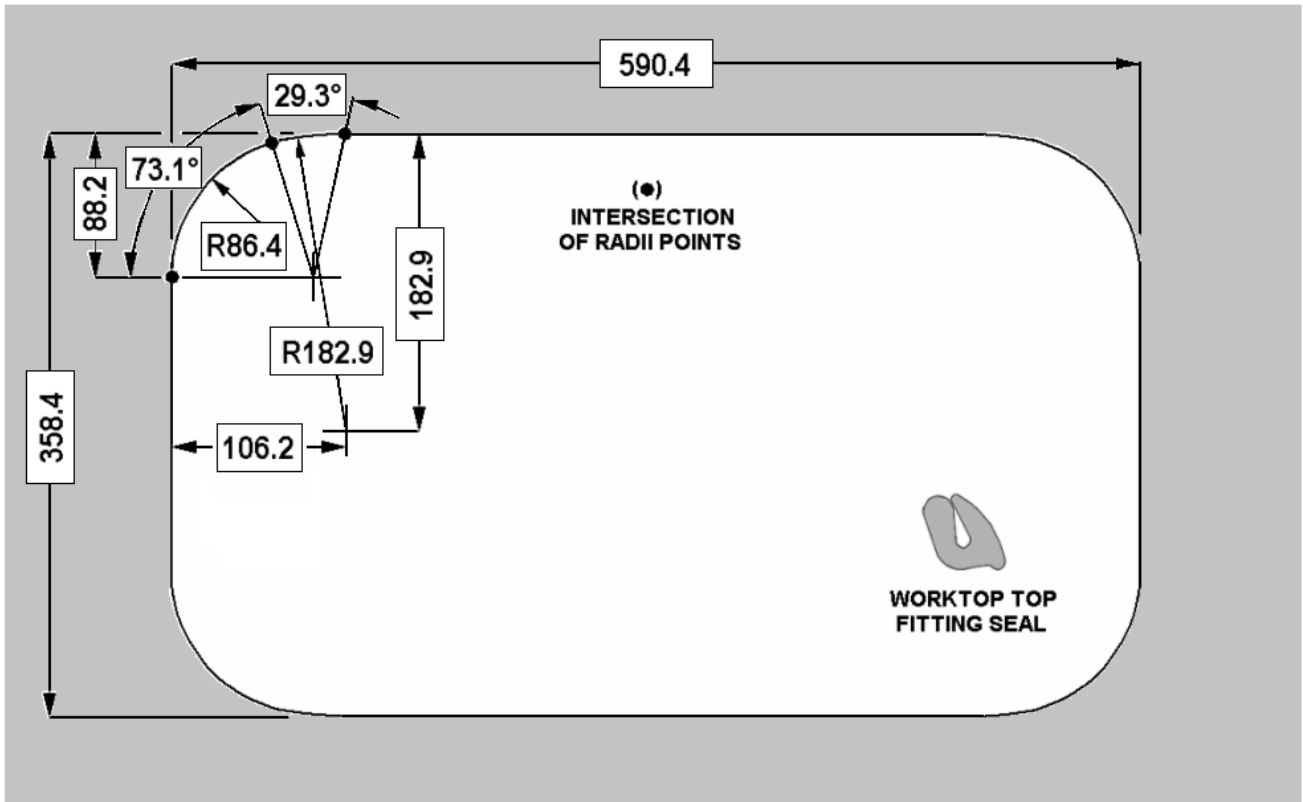

FIG. 2 APPLIANCE LOCATION

- (A) Any adjoining wall surface situated within 200mm from the edge of any hob burner must have a suitable non-combustible material for a height of 150mm for the entire length of the hob. For models with a glass lid, the distance from the edge of the burner to the rear wall can be reduced to 110mm.
- (B) Any combustible construction above the hob must be at least 600mm above the top of the burner and no construction shall be within 450mm above the top of the burner.
- (C) Not less than the appliance width



SERIES 162 & 167 WORKTOP CUTOUT



SERIES 164 WORKTOP CUTOUT

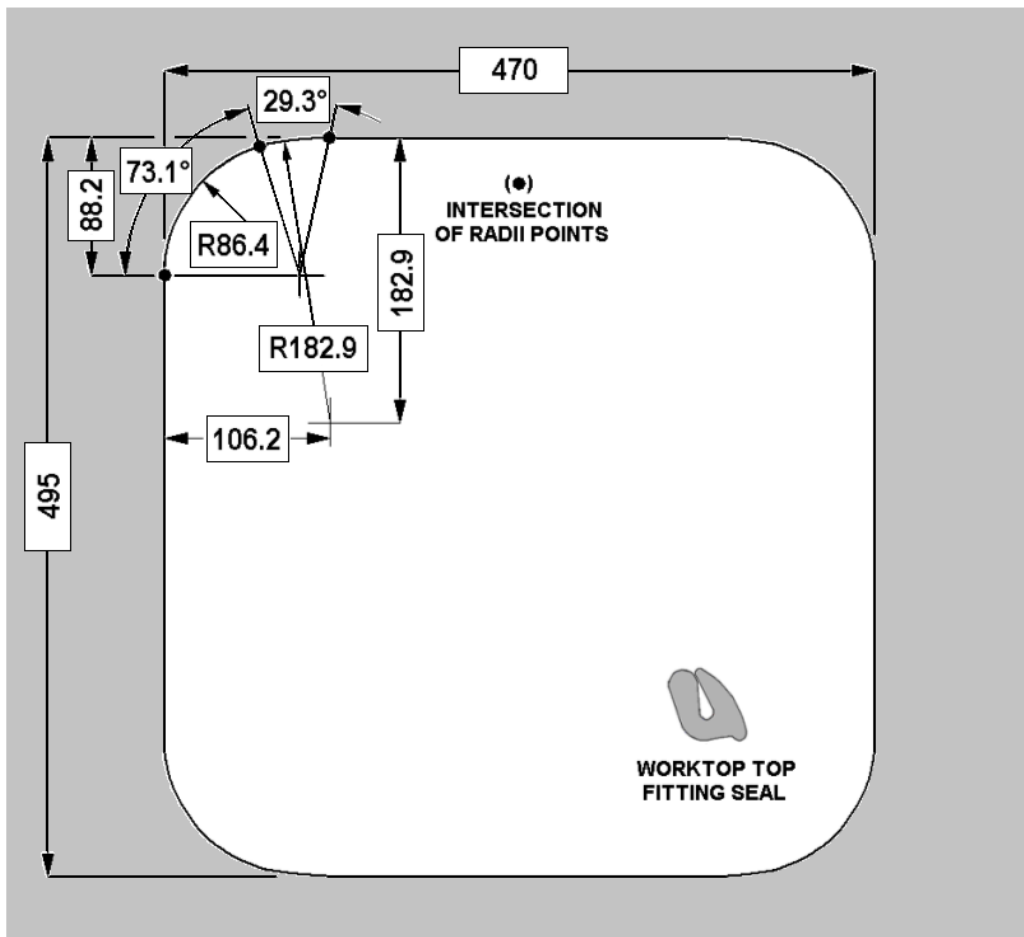

SERIES 169 WORKTOP CUTOUT

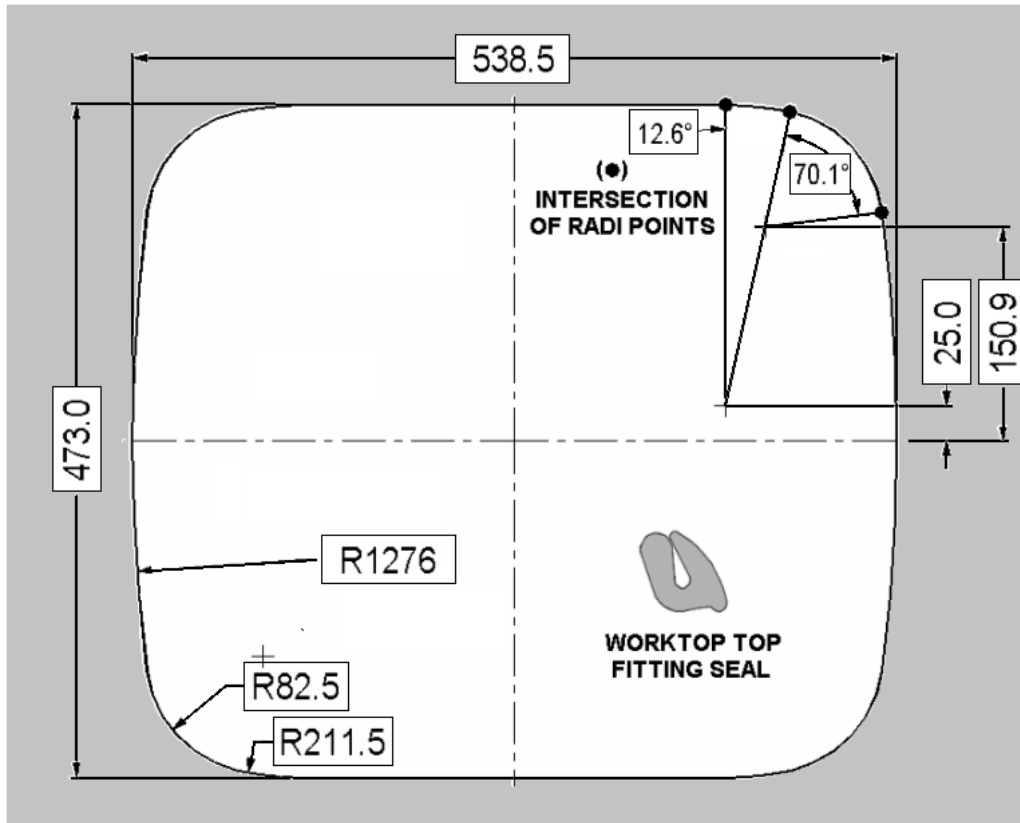

SERIES 169 WORKTOP CUTOUT (FLUSH MOUNTING)

FLUSH FITTING; SEAL TYPE 

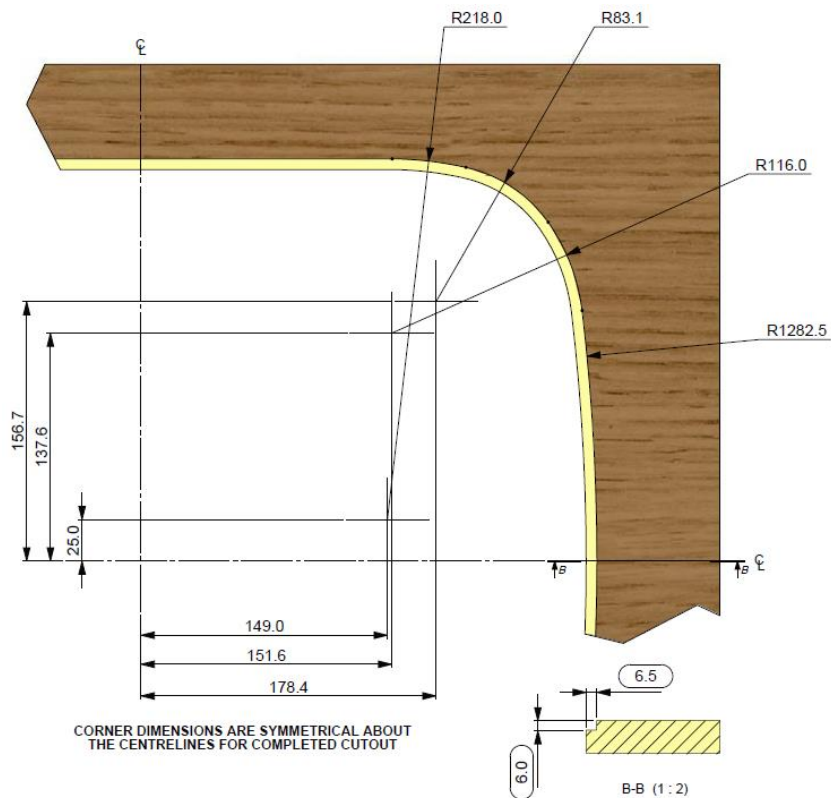
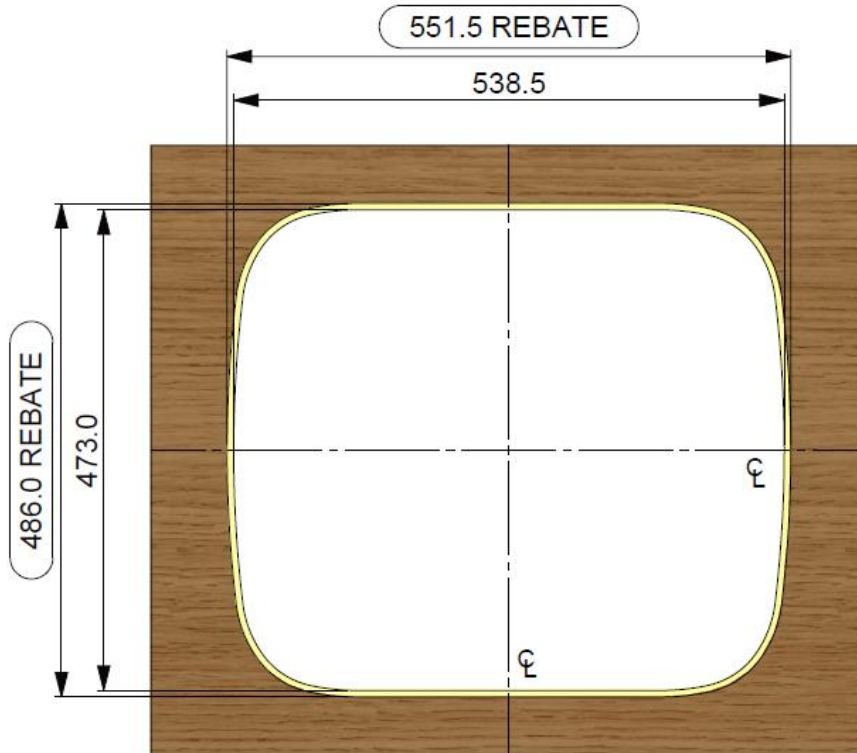

SERIES 162, 164, 167 & 169, TOP MOUNT SEAL & CLAMPING

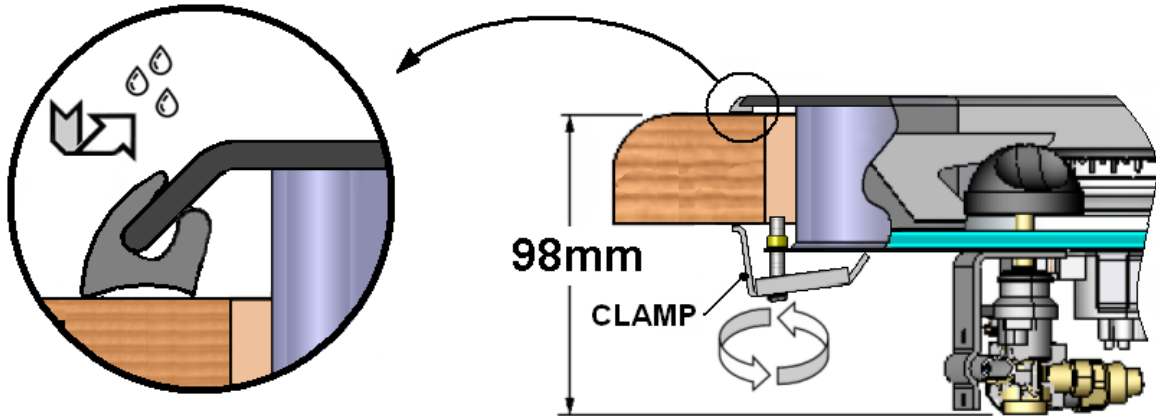

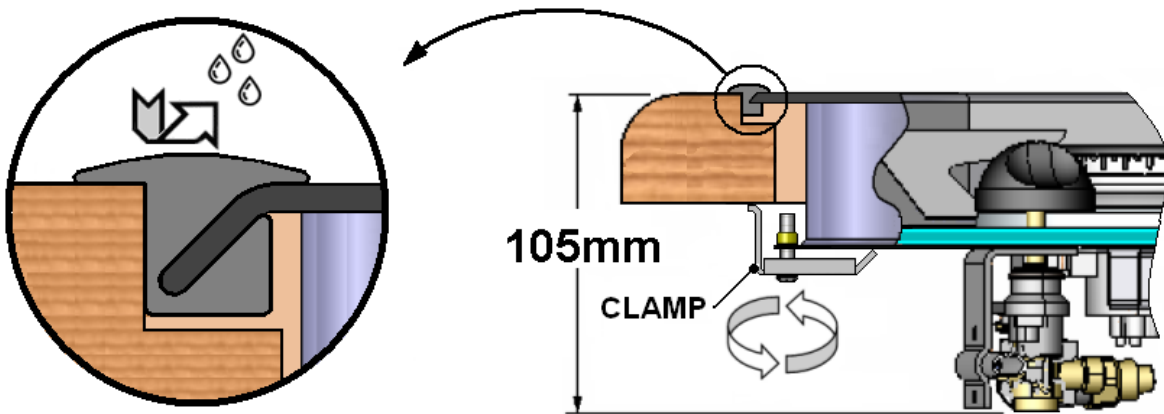

SERIES 169, FLUSH MOUNT SEAL & CLAMPING

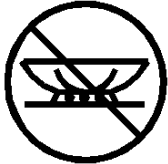

SYMBOLS DESCRIPTION

	Do not remove the pan support and enclose the burner with a wok stand as this will concentrate and deflect heat onto the hotplate
---	---

	Do not place anything, e.g. flame tamer, asbestos mat, between pan and pan support as serious damage to the appliance may result
---	--

	Do not use large pots or heavy weights which can bend the pan support or deflect flame onto the hotplate
---	--

INTRODUCTION

In your own interest of safety, gas appliances should be installed by competent persons. Failure to install the appliance correctly could invalidate any warranty or liability claims. This appliance shall be installed in accordance with the manufacturer's installation instructions, local gas fitting regulations, municipal building codes, AS/NZS5601 and any other relevant statutory regulations.

Data Label

The data label is located on the underside of the control panel area towards the front of the appliance. A duplicate data label is supplied to adhere to an accessible area next to the appliance. This appliance is designed for use with Universal LPG only and should not be converted for use with any other gas.

Provision of Ventilation

The use of a gas cooking appliance results in a production of heat, moisture and products of combustion in the room in which it is installed. Ensure compliance with the current ventilation requirements in the AS/NZS 5601 Installation Code. The installation must provide for adequate air supply for combustion to the burners, safe removal of combustion products and avoidance of the accumulation of unburned gases.

Location

Chose a location free of draughts away from open doors and clear of combustible materials or other fire hazards. The location should ensure convenience of operation and service. Any adjoining wall surface situated within 200mm from the edge of any hob burner must have a suitable non-combustible material for a height of 150mm for the entire length of the hotplate. Any combustible construction above the hotplate must be at least 600mm above the top of the burner and no construction shall be within 450mm above the top of the burner



WHERE THIS APPLIANCE IS INSTALLED IN MARINE CRAFT OR IN CARAVANS, IT SHALL NOT BE USED AS A SPACE HEATER.



- This appliance is designed for use with Universal LPG and should not be converted for use with any other gas
- Use only the Gas Pressures specified
- This appliance MUST be earthed



- Glass lids may shatter when heated. Turn off all burners before shutting the lid.
- Spillage on the lid surface should be removed before opening the lid
- The Glass lid has the tendency to snap shut towards the end of lowering. This is caused by the travel lock action of the hinges as it is activated. Make sure all fingers are clear of the appliance when closing the lid.

OPERATION

The burners are controlled individually, and each is monitored by a thermocouple probe. In the event the burner flames are accidentally extinguished, turn off the burner control and do not attempt to re-ignite the burner for at least one minute.



1. Ensure gas supply is connected and turned on.
2. Push in the control knob and turn anticlockwise to full rate – large flame (🔥) Fig. 1.
3. Continue holding the knob depressed whilst the automatic ignition lights the burner. For manual models hold a lighted match or taper to the burner.
4. After the burner is lit continue depressing the knob for approximately 10 - 15 seconds.
5. Release knob and turn to required heat setting – see Fig. 1.
6. If burner has not lit within 15 seconds, release knob and wait at least 1 minute before repeating operations (2) to (5).
7. To turn off, rotate the control knob until the line on the knob is aligned with dot on the control panel.

DO'S AND DON'TS

- | | |
|--------|---|
| DO | Read the user instructions carefully before using the appliance for the first time. |
| DO | Allow the burners to heat before using for the first time, in order to expel any smells before the introduction of food. |
| DO | Clean the appliance regularly. |
| DO | Remove spills as soon as they occur. |
| DO | Check that controls are in the off position when finished. |
| DO NOT | Allow children near the appliance when in use. Turn pan handles away from the front so that they cannot be caught accidentally. |
| DO NOT | Allow fats or oils to build up in the base of the hotplate. |
| DO NOT | Use abrasive cleaners or powders that will scratch the surfaces of the hotplate. |
| DO NOT | Under any circumstances use the appliance as a space heater. |

LEAKS

If a smell of gas apparent, the supply should be turned off at the cylinder **IMMEDIATELY**. Extinguish naked lights including cigarettes and pipes. Do not operate electrical switches. Open all doors and windows to disperse any gas escape. Universal LPG is heavier than air; any gas escaping will therefore collect at low level. The strong unpleasant smell of gas will enable the general area of the leak to be detected. Check that the gas is not escaping from an unlit appliance. Never check for leaks with a naked flame; leak investigation should be carried out using a leak detector spray or soapy solution.

	<ul style="list-style-type: none">• When cooking, keep children away from the vicinity. Turn pan handles inwards so they cannot be caught accidentally.• When finished, check that all controls are in the off position.• If fitted in a touring caravan or motor van, all burners should be extinguished when the vehicle in which the appliance is installed is moving and the cylinder valve to the appliance should be turned off.
	<ul style="list-style-type: none">• Depending on specification, your appliance may be fitted with a glass lid shut-off system, which cuts off the power to all hotplate burners when the lid is closed.• Ensure the glass lid is fully open before turning on the hotplate burners.

MAINTENANCE

We recommend an annual service by an authorised service agent to maintain efficient appliance performance. This appliance needs little maintenance other than cleaning. All parts should be cleaned using warm soapy water. Do not use abrasive cleaners, steel wool or cleansing powders. When cleaning the burner ring it is essential to ensure that the holes do not become blocked. Do not leave wet cloths, cleaning pads, residues of food, cleaning products or other material to dry on the appliance surfaces, as it can cause pitting or staining of the surface.

The control knobs are a push fit and can be removed for cleaning. They are interchangeable without affecting the sense of operation.

Any of the following are considered abnormal operation and may require servicing.

- Yellow flames (some yellow tipping is normal).
- Sooting of cooking utensils.
- Burners not igniting properly.
- Burners failing to remain alight
- Burners extinguished by cupboard doors.
- Gas valves that are difficult to turn

For service, please contact your authorised local Service Agent giving full details of the model, serial number and date of purchase.

Manufactured by:

THETFORD Limited.
Unit 6 Brookfields Way
Manvers
Rotherham S63 5DL. England



- DO NOT USE OR STORE FLAMMABLE MATERIALS IN THE APPLIANCE STORAGE DRAWER OR NEAR THIS APPLIANCE.
- DO NOT SPRAY AEROSOLS IN THE VICINITY OF THIS APPLIANCE WHILE IT IS IN OPERATION.
- DO NOT MODIFY THIS APPLIANCE.

INSTALLATION

A cut-out should be prepared in the worktop, and the appliance fixed in position – worktop cutout details for each model are provided on pages 5 and 6.

A direct distance of 200mm must exist between the edge of the appliance burners and any combustible material, unless protected by a layer of non-combustible material. All combustible materials such as curtains and shelves must be kept well clear of the appliance.

Any combustible construction above the hotplate must be at least 600mm above the top of the burner and no construction shall be within 450mm above the top of the burner – see Fig. 2.

The underside of the appliance must be shielded. It is recommended that the shield is fabricated from non-combustible material, but if the enclosure is manufactured from combustible material, then a minimum air space of 25mm must exist between the material and the lowest part of the appliance. This air space must be well ventilated. Thetford recommend that provision is maintained for the safe dispersal of any unburned gas beneath the appliance.

INSTALLATION

Connection

A ¼ BSP female connection is provided on the underside of the appliance. It is recommended that the appliance be connected by copper tubing; a rubber or hose connection must not be used. After connection the appliance must be tested for soundness. The gas inlet must be accessible with the appliance installed to ensure installation in accordance with AS/NZS5601.

This appliance is suitable for use with;

Universal LP Gas Only 2.75 kPa.

It is important that the regulator should be set to the correct pressure for the type of gas being used. Excessive pressure must not be permitted.

If the flame on hob burners has a tendency to lift, it is probable that the line pressure is too great. Should there be excessive yellow tips (resulting in sooting) then it is probable that the line pressure is too low and, in either case, the burners should not be used until the line pressure has been checked.

The burners on this appliance have fixed aeration and no adjustment is necessary.

When satisfied with the appliance, please instruct the user on the correct method of operation. If the appliance fails to operate correctly after all checks have been made, refer to the authorised service provider in your area.

	<ul style="list-style-type: none">• After installation the appliance MUST be tested for soundness• Test ALL burners on high and low flame for flame stability.• The gas supply input pressure MUST not rise or fall significantly from nominal when ALL appliances connected to the supply are operated simultaneously. If NOT installed to the manufacturer's instructions detailed herein, we the manufacturer can not be held responsible for any problems that occur, or poor performance that is perceived/witnessed.
---	---

SERVICING

ALL SERVICING MUST BE CARRIED OUT BY AN AUTHORISED PERSON. AFTER EACH SERVICE THE APPLIANCE MUST BE CHECKED FOR GAS SOUNDNESS

Details of the injector orifice size are provided within the specification tables on pages 2 & 3. To verify the system is operating at the correct pressure a pressure test point is provided on the gas manifold, located below the control panel. The pressure is measured with Semi Rapid burner on high flame and with an inlet pressure of 2.75 kPa (Universal LPG).

1. Removing the hob

- Isolate the gas supply and disconnect inlet pipe
- Disconnect 12v power wires to spark generator.
- Release the worktop clamps from beneath the appliance. Lift and place the hob onto a suitably protected surface.

SERVICING

2. Hob Burner Gas valve removal/replacement

- Shut off gas supply and disconnect gas supply pipe from the unit.
- Remove the hob from the bench top.
- Remove the appropriate control knob by pulling up.
- From underside of hob, disconnect appropriate thermocouple at the gas valve.
- Unscrew the appropriate gas supply pipe nut.
- Remove the appropriate gas valve clamp by unscrewing the two screws.
- Unscrew the gas valve retaining nut.
- Remove the gas valve.
- Replace the tap and gasket. Refit using reverse procedure.

3. Hob Burner Injector removal/replacement

- Rotate the pan support to release from the security clips and pull up to release it from the stainless spillage boss.
- Remove the two screws and lift off the burner cap and skirt.
- With a 7mm A/F socket, unscrew injector from the bottom of the burner mixing tube.
- Replace/refit using the reverse procedure.

4. Thermocouple removal/replacement

- Shut off gas supply and disconnect gas supply pipe from the unit.
- Remove the hob from the bench top.
- From the underside of the hob, disconnect the appropriate thermocouple at the gas valve.
- Remove the spring clip retaining the thermocouple at the burner.
- Remove the thermocouple.
- Replace/refit using reverse procedure.

5. Spark Ignition (where fitted)

- Disconnect from gas supply.
- Disconnect 12v power wires to spark generator.
- Remove appliance from housing.

12v Spark Generator replacement

- Located on the underside of appliance.
- Remove all electrode wires.
- Unscrew and/or unclip the spark generator and lift off the unit.
- Replace/refit using reverse procedure

Spark Ignition Wires

- Pull off the fixing clip on the burner and remove electrode from the burner cup.
- Trace the electrode wire back to the generator and pull off the connector.
- Replace/refit using reverse procedure

FAULT DIAGNOSIS

FAULT	CAUSE	SOLUTION
Burner will not adjust (continuous on low or high flame).	Gas pressure Blocked jet Control tap	Check gas pressure correct Clear blockage from jet. Check jet size correct Inspect/test control tap
Burner sooting.	Gas pressure	Check pressure, low pressure is the cause of sooting.
Burner – no Spark Ignition	Power supply Poor connection Spark generator	Check power supply Check all connections Test spark generator Earth leakage due to damaged wire
Discoloured pan-rest	Not a fault	Discolouration is unavoidable. Chrome pan-rests are more susceptible to discolouration
Burner will not remain lit	Thermocouple failure. Blocked jet	Test & replace thermocouple if required Check thermocouple in flame path Clear jet blockage