



Vegetable Preparation Machine

RG-100

Food Preparation Machines - Made in Sweden since 1941 

5 kg
/min

400
/day



halde.com

Size that matters

The RG-100 is designed to suit the kitchen with smaller volumes but needs the quality and power of a large professional vegetable preparation machine. The size makes the machine suitable to use directly on a kitchen workbench. The leaning design means that the feed cylinder is always positioned at the right angle making it easy to top up.

Safe and quick top ups

Thanks to the automatic start and stop function the machine stops as soon as the pusher plate is swung aside. When it is swung back the machine restarts and you can continue working. A clear advantage, particularly when larger volumes are involved.

Double safety against unprotected cutting tools

If the feed cylinder is removed the power is cut. Thanks to this double security there is no risk of the machine starting with an unprotected cutting tool.

Developed for the best hygiene

The RG-100 is manufactured solely from hygiene certified material. The machine has smooth surfaces, rounded edges and has no unnecessary recesses where food might penetrate and get stuck.

Accessories that simplify life in your kitchen

• Angle Cut Feed Head

Used for slicing long and narrow vegetables such as cucumbers, carrots and leeks to get angled decorative slices for wok dishes, sandwiches, salads etc.



• Pipe insert incl. Pestle

Used for continuous feeding of long and thin vegetables that are to be cut "standing", for example spring onion, chilli and radish. The pipe insert is placed in the inbuilt tube feeder.



• Machine table for a better ergonomomy

The table can be set at three different heights (high, medium, low) so that correct ergonomic posture is always guaranteed. The design of the table allows easy accommodation of HALLDE's Container Trolley.



• Container Trolley for a smooth flow

Facilitates the handling of cut products, transporting them easily to subsequent stages of the preparation process. Can be adjusted to different heights and even folded up completely. The trolley is made entirely of stainless steel, with four sturdy wheels, two of which are lockable.



• Cleaning brushes in two sizes

Used for cleaning machines and cutting tools. Both have coarse bristles that are particularly effective for cleaning Dicing Grids and Julienne Cutters.



• Wall rack for Cutting Tools

Provides space for three cutting tools and a quick overview of the entire range, saving space and making handling safe and comfortable – an effective way of protecting the edges of the blades from unnecessary wear.



Easy cleaning

For quick cleaning, all loose parts are simple to remove for easy rinsing of the machine. The feed cylinder is removable and can be cleaned under running water.

Only the best material

Machine base, feed cylinder and pusher plate are all made of robust metal. Only top quality stainless steel is used to manufacture the cutting tool knife blades.

Lightweight and easy to move

The relatively small size of the machine gives several advantages. It does not take up a lot of space in the kitchen. You can use it as a table top machine. And it is easy to move, something which is helped by the generously sized handle on the back.

Highest possible reliability

The powerful motor has a high starting and running torque and powers the direct-driven cutting tool. No belts or intermediate connections. The power from the motor goes via a maintenance free gear drive. This makes the RG-100 an exceptionally reliable machine – irrespective of the products you are preparing.

Cutting tools with complete register

Our wide range of cutting tools means the RG-100 can handle every conceivable task. You choose the cutting tool you need to improve efficiency throughout the kitchen. The RG-100 slices, dices, shreds, grates, cuts juliennes and crimping slices – everything from firm to soft products. The knife blades and grating plates are replaceable. As a result you do not need to buy new cutting tools.

Always perfect cutting results

The rotation speed of the cutting tools is optimised for cutting fine and even slices as efficiently as possible. The knife blades are purposely sharpened to avoid inertia or the edge breaking off.

































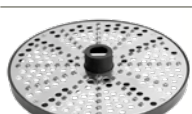



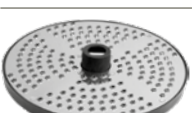





Result- och inspiration videos →

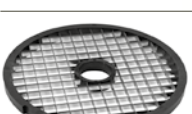

High quality cutting tools for best results

All cutting tools are dishwasher safe.  Replaceable knives / plates.  = Stainless steel.

	Slicer   0.5, 1, 1.5, 2, 3, 4, 5, 6, 7, 8, 9, 10 mm	Slices firm and soft vegetables, fruits, mushrooms etc. Dices when combined with a suitable Dicing Grid. Cut French fries in combination with Potato Chip Grid.	
	Fine Cut Slicer  15 mm	Slices firm and soft vegetables, fruits, mushrooms etc. Dices when combined with a suitable Dicing Grid.	
	Soft Slicer  8, 10, 12, 15 mm	Slices soft vegetables, fruits, mushrooms etc. Preferably used when dicing soft products, in combination with a suitable Dicing Grid.	
	Crimping Slicer   2, 3, 4, 5, 6 mm	Cuts decorative rippled slices of beetroot, cucumber, carrots, etc.	
	Julienne Cutter   2x2, 2x6, 3x3, 4x4, 6x6, 8x8, 10x10 mm.	Cuts julienne of firm products for soups, salads, stews, decorations etc. Suitable to cut slightly curved French fries.	
	Grater/Shredder   1.5, 2, 3, 4.5, 6, 8, 10 mm.	Grates carrots and cabbage for raw salads. Grates nuts, almonds and dry bread. Grater 6 or 8 mm is commonly used for grating cheese for pizza and when shredding cabbage.	
	Fine Grater  	For finely grating products such as raw potatoes for Swedish potato pancakes and bread for making breadcrumbs.	
	Hard Cheese Grater  	Ideal for grating hard cheese such as parmesan. Produces a somewhat coarser grate than the Fine Grater, Extra fine.	
	Fine Grater, Extra fine  	Grates products very finely, such as black radish grated for purée and potatoes for mashing.	
	Dicing Grid  6x6, 8x8, 10x10, 12x12, 15x15, 20x20 mm	Cuts dices in combination with a suitable type of slicer. Dice both hard and soft vegetables, fruits etc.	
	French Fries kit  10x10 mm	Kit containing French Fries Slicer and French Fries tool used together to cut French fries.	





Machine

- Motor: 0.25 kW. One-speed. 100 V, single phase, 50-60 Hz. 110-120 V, single phase, 60 Hz. 220 V, single phase, 50 Hz. 230-240 V, single phase, 50 Hz. 230 V, three phase, 50 Hz. 400 V, three phase, 50 Hz. 440 V, three phase, 60 Hz.
- Transmission: Planetary gearing.
- Safety system: Two safety switches.
- Degree of protection machine: IP44.
- Degree of protection push buttons: IP65.
- Power supply socket: Earthed, single phase, 10 A alternatively earthed, three phase, 10 A slow-blow.
- Fuse: 10 A, delayed action fuse.
- Sound level LpA (EN31201): 70 dBA.
- Magnetic field: Less than 0.5 microtesla.

Materials

- Machine housing: Anodized and polished aluminium alloy.
- Cutting tool discs: Stainless steel/ Aluminium/ Fiberglass reinforced polyamide.
- Cutting tool knife blades: Stainless knife steel.
- Machine table: Stainless steel.
- Container: Polycarbonate.

Feeder

- Feed cylinder: Volume 1.65 litre. Height 150 mm. Diameter 170 mm.
- Feed tube with internal diameter 56 mm.

Cutting tools

- Diameter: 185 mm.
- Speed: 350 rpm (50 Hz), 420 rpm (60 Hz).

Type of preparation

- Slices, dices, grates, shreds, cuts julienne, French fries and crimping slicers.
- Processes vegetables, fruit, dry bread, cheese, nuts, mushrooms, etc.

Users

- Restaurants, shop kitchens, diet kitchens, retirement homes, hospitals, schools, fast food outlets, catering, day care centres, salad bars, pizzerias, ships, etc.

Net weights

- Machine: 16 kg.
- Cutting plates: 0.5 kg. French Fries kit: 0.9 kg.

Standards

- Directive: Visit Halldé.com and select product and Certification.

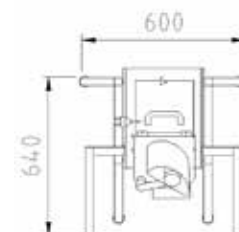
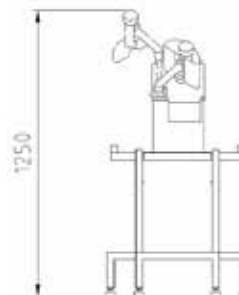
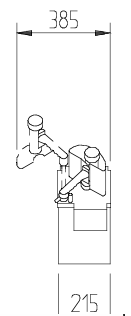
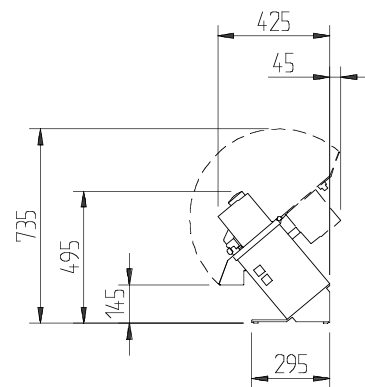

Food Preparation Machines
Made in Sweden since 1941

AB Halldé Maskiner – P.O. Box 1165 SE-164 26 Kista Sweden

• Phone: +46 8 587 730 00 • Fax: +46 8 587 730 30 • halldé.com • info@halldé.com

