

NULINE
REFRIGERATION



**PR350 PHARMACY
REFRIGERATOR**
Warranty, Installation,
Maintenance & Operational
Manual

+61 3 9562 3355
info@nuline.au
www.nuline.au

CONTENTS

Introduction

Your New Nuline Cabinet.....	3
Disclaimer.....	3
Warranty.....	3
General and Safety Precautions.....	4

Product Overview

Cabinet Description	6
PR350.....	6
Silver Information Label.....	7
Specifications	8

Installation

Setting Up	9
Handling.....	9
Unpacking	9
Positioning	10
Refrigeration.....	12
Electrical Connection	13
Plumbing.....	14
Shelves.....	15
Adjustable Shelf Installation.....	15
Loading Restrictions.....	15
Locking	16
Temperature Probes.....	17

Operation

Initial Start-Up & Operation	18
Controller.....	18
Initial Start Up.....	19
Cabinet Temperature	20
Product sensor.....	20
Refrigerator Defrost Cycle – Automatic...	21
Alarm	21

Maintenance

Cleaning	22
General Information.....	22
Corrosion Protection.....	22
Surface Finish.....	23
Cleaning Schedule.....	24
Cabinet Interior	24
Door Seal.....	24
Glass Door	24
Ventilation Panels / Filter	25
Condenser	25
Temperature Adjustment.....	26
Temperature Controller Parameters	26
To Change the Parameter Password	26
Parameter Table	27
Inactivity for Extended Period	28
Disposal	29



WARNING

If the cabinet is not working as it should on first use please contact us right away and do not use the cabinet.

INTRODUCTION

Your New Nuline Cabinet

Thank you for choosing a Nuline cabinet please read through the warranty, manual and specifications of your cabinet carefully to become familiar with your new cabinet.

Our cabinets are designed and manufactured to meet the specialized needs of the biomedical industry. With correct care and maintenance in accordance with these instructions, your new cabinet will provide many years of reliable service.

Nuline Refrigeration has been manufacturing refrigerators and freezer cabinets in our Melbourne factory for the Australian market since 1985. Our specialized range of biomedical cabinets that are Australian made and imported from selected global suppliers, are used extensively across hospitals, medical centres, pharmacies, and laboratories.

Carefully read this instruction booklet, as it contains important advice for safe installation, operation, and maintenance. Keep this booklet on hand in a safe place for future reference by other users.

Disclaimer

Nuline refrigeration cabinets are designed for the storage of cooled, chilled or frozen biomedical products, such as vaccines, laboratory samples, and, but not limited to pharmaceutical drugs and medication.

The use of Nuline cabinets for any other application is not warranted unless subject to prior approval by Nuline. The cabinets are designed specifically to store products that are already cooled, chilled or frozen to the required temperature.

The cabinets are not designed to be ordinarily switched off as bacteria growth, mould, odours, rust, or water overflow could occur.

Transportation of the cabinet must be always done with the cabinet upright, do not lay the cabinet on sides, front, or back.

Warranty

Our warranty can be found on our website at www.nuline.au and alternatively you can scan this QR code.



INTRODUCTION

General and Safety Precautions

To prevent personal and material injury when using any electrical cabinets, safety precautions must always be observed.

Our cabinets have been designed for high performance. The cabinet must be used exclusively for the purpose for which it has been designed for.

Read and understand this manual, if in doubt contact Nuline Refrigeration.

- All cabinets **MUST** be installed according to the procedures stated in the installation section of this manual.
- In the case of new personnel, training is to be provided before operating the cabinet.
- **DO NOT** use this cabinet for any other purpose than its intended use.
- **DO NOT** store explosive substances such as aerosol cans with a flammable propellant in or near this cabinet.
- Keep fingers out of "pinch point" areas.
- The cabinet is not waterproof **DO NOT** use jet sprays, hoses or pour water over / on the exterior of the cabinet.
- Only use this cabinet with voltage specified on the rating label.
- **DO NOT** remove any cover panels that may be on the cabinet.
- **DO NOT** use sharp objects to activate controls.
- **DO NOT** use sharp objects to remove ice from the cabinet.
- If any fault is detected, refer to troubleshooting.
- This appliance is **NOT** suitable for storing and cooling blood, blood plasma or similar substances. Any misuse of the appliance may result in damage to or spoilage of stored goods.
- **DO NOT** allow naked flames or ignition sources to enter the appliance.
- **DO NOT** stand on the drawers, shelves or doors or use them to support anything else.



INTRODUCTION

- **DO NOT** insert metal objects such as a wire into any vents, gaps, or any outlet on the cabinet. This may cause electric shock or injury by accidental contact with moving parts.
- When connecting and disconnecting the appliance, pull on the plug, not on the cable. Pulling on the cable has the potential to damage the cable, this could result in electric shock or fire by short circuit.
- This appliance is not suitable for operations in outdoors or areas where it is exposed to splash water or damp conditions.
- This appliance is not suitable for operation in potentially explosive atmospheres.
- Keep the cabinet and surrounding areas clean, dry, and uncluttered.
- The manufacturer declines any liability for damages to persons and / or things due to an improper / wrong and / or unreasonable use of the machine as well any failure of the refrigeration system.
- Only specifically trained / qualified Technicians (one of our service agents, or a similarly qualified persons) should carry out all repairs, maintenance, and services.
- Disconnect the power cord if there is something wrong with the cabinet.
- Nuline Refrigeration will not be held liable for any potential loss of stock due to failure of the refrigeration system and / or any other failure of the cabinet.

PRODUCT OVERVIEW

Cabinet Description



	IMPORTANT
	This unit is only designed to maintain the product at the controlled temperature.
	CAUTION
	This unit includes refrigeration components. DO NOT touch the cold refrigeration components

PRODUCT OVERVIEW

Silver Information Label

The silver information label is placed on the back of the cabinet.

NULINE REFRIGERATION		
Model	PR350	
Serial No	19060	
Voltage	220-240	VOLT
Frequency	50	HZ
Current	0.8	AMPS
Light	LED	WATT
Element		WATT
Range		WATT
Capacity	350	LITRES
Refrigerant	R600a .081	KG
Nuline Refrigeration T: (03) 9562 3355 W: www.nulinerefrigeration.com.au E: info@nuline.au		

PRODUCT OVERVIEW

Specifications

Model	PR350
Gross Capacity	350 L
External Dimensions in mm (w/d/h including castors)	595 x 650 x 1850
Internal Dimensions in mm (w/d/h)	455 x 445 x 1685
Packed Dimensions in mm (w/d/h including pallet)	640 x 670 x 2010
Gross Weight - kg (packed weight)	94
Net Weight - kg	77
Energy Consumption	1.1 kWh/24
Voltage	240V
Temperature Range	2°C to 8°C
Ambient Temperature Range	10°C to 32°C
Refrigerant	R600a
Cooling System / Defrost	Fan Forced / Automatic
Exterior Cabinet Finish	Enamelled Steel
Inner Liner Material	ABS
Door	Self Closing Glass
Door Hinge	RH
Type of Controller	Digital
Temperature Display	External
Door Ajar Alarms	Standard
Fan Cutout on Opening	Standard
High and Low Readout	Visual / Audible
Power Requirement	10amp GPO
Amps	0.8
Castors	Levelling Legs
Adjustable Shelves	7
Usable Shelf Area in mm(w/d)	6 x 455 x 405 1 x 438 x 202
Light	LED
Self Closing Door	Standard
Data Logger	Optional
Uninterruptible Power Supply Unit with Back Up Battery	Optional
Preventative Maintenance Program	Optional
BMS Connectivity	N/A
Port Entry	N/A

INSTALLATION

Setting Up



WARNING

Improper installation, adjustments, alternations, service, or maintenance can cause property damage, injury, or death.

Handling

- To prevent injury or damage to the unit, take the proper precautions when moving the cabinet.
- For larger cabinets moving equipment such as a forklift or pallet trolley should be used (the forks should be completely under the pallet)
- Ensure that the cabinet is always level.

Unpacking

- Before and after unpacking, the cabinet should be checked for damage.
- If there is any damage, please contact the distributor and/ or manufacturer within 24-48 hours of receipt and before connecting to the mains.
- The cabinet is supplied fully assembled.
- Remove all protective plastic film, tapes, ties, and packers before installing and operating.
- Clean off any residual from the interior / exterior of the cabinet using a clean cloth and warm soapy water.



WARNING

Danger of suffocation due to packing material and plastic film.
Do not allow children to play with packaging material.
Take the packaging material to an official collection point.

INSTALLATION

Positioning

1. Ensure that the cabinet is on a horizontal and level floor.
 - If your cabinet comes with front levelling feet, you may adjust them to ensure the cabinet is level.
 - If the cabinet is on castors the front two breaks on the castors must be engaged to ensure the cabinet stays in the correct position.
2. Do not position the cabinet in:
 - Wet areas
 - Near heat and / or steam sources
 - Near flammable substances
3. Ensure there is 60mm ventilation space on sides, 100mm on the rear, and 200-300mm on top of refrigerator for proper air flow. See example below.
4. The cabinet should not be installed in any manner that would impede normal service access.
5. Please wait at least 2 hours before switching the cabinet ON as this will allow the refrigeration gas in the refrigeration system of the cabinet to settle due to movement and handling during freight.

INSTALLATION

Large Cabinets

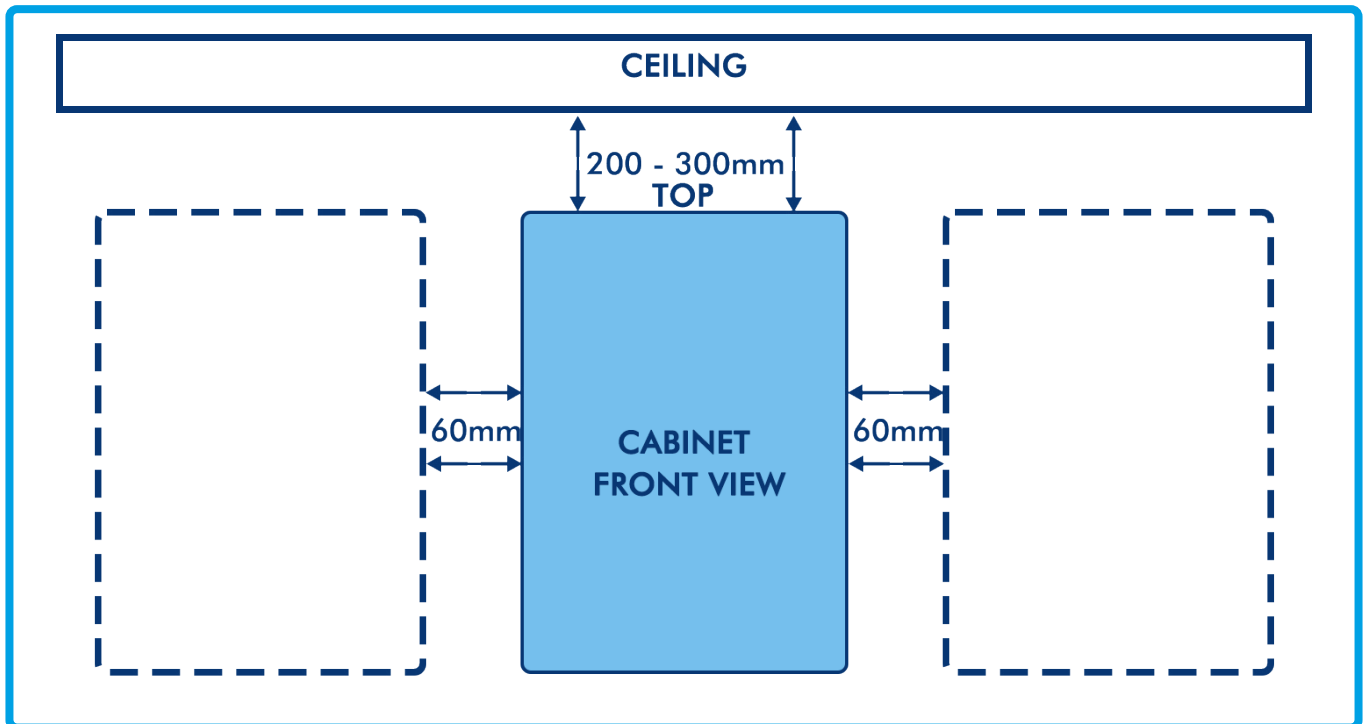
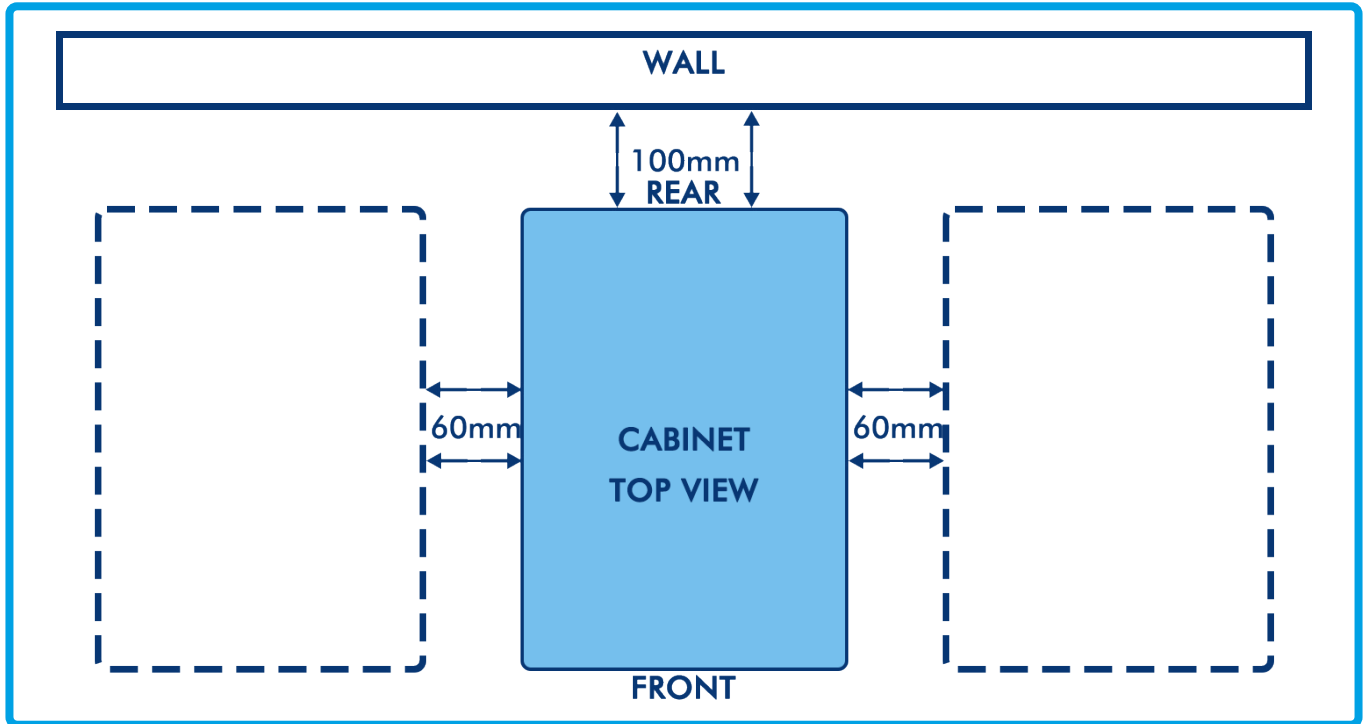

INSTALLATION

Refrigeration



WARNING

System charged with flammable refrigerant.
If there is a suspected refrigerant leak, turn the cabinet off and contact Nuline Refrigeration if under warranty; if no longer warranty contact your preferred qualified services technician.

This cabinet is fully operational once it leaves our factory, no additional refrigeration setup is required.

INSTALLATION

Electrical Connection

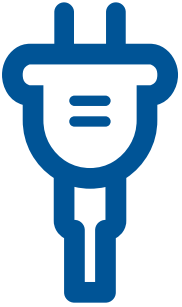

WARNING

Some procedures in this manual require the power to the equipment to be turned off and isolated. Turn the power OFF at the power point and unplug the power supply lead by the plug body. If the power point is not readily accessible turn the equipment off at the isolation switch or the circuit breaker in the switchboard. Attach a yellow "CAUTION-DO-NOT OPERATE" tag. This must be performed where relevant unless the procedures specify otherwise.
FAILURE TO DO SO MAY RESULT IN ELECTRIC SHOCK.

Single Phase Units:

Supplied and fitted with an appropriately rated plug and lead, 10A plug.

When connecting and disconnecting the appliance, pull on the plug, not on the cable.

Notes:

If the supply cord is damaged, it must be replaced by the manufacture, its service agent, or similarly qualified persons in order to avoid a hazard. Please contact Nuline for parts and we will advise how to do this in order to avoid any electrical hazard.

The power cable should be dry and isolated from moisture and water.

INSTALLATION

Plumbing

No additional drainage or plumbing is required.

INSTALLATION

Shelves

Adjustable Shelf Installation

- Fully open the door.
- Remove the shelf.
- Find the shelf grooves on either side of the interior walls at your desired level.
- Carefully place the edge of the shelf into the grooves on either side.
- Gently push the shelf fully inside the cabinet

When loading the shelves with product, care should be taken to ensure that the product is loaded evenly to allow for proper air circulation around all products.

Loading Restrictions

- There should NOT be any overhang of products on the shelves.
- Shelves are only designed to hold one layer of product. Overloading can break / damage the shelves and prevent proper air flow.
- Remove some products if the shelves are flexing or bending.
- Shelves should be adjusted to allow air space around all the product to ensure proper air flow and even refrigeration to ensure efficient operation of the cabinet.

INSTALLATION

Locking

This cabinet comes standard with a key door lock. It is recommended not to keep the key in the lock during normal use. This will prevent the bending or breaking of the key inside the lock. If the key is broken inside the lock, the lock will have to be replaced.

Keeping the key removed from the lock will also prevent the lock from accidentally locking when the door is open. Locking when the door is open could prevent the door from closing properly, resulting in the cabinet temperature to rise.

INSTALLATION

Temperature Probes

This cabinet is equipped with a temperature probe inside the unit that monitors the temperature inside the cabinet. This probe also controls the temperature alarms.

To monitor the temperature in various areas of the interior of the cabinet, external probes can be installed through the port entry.

OPERATION



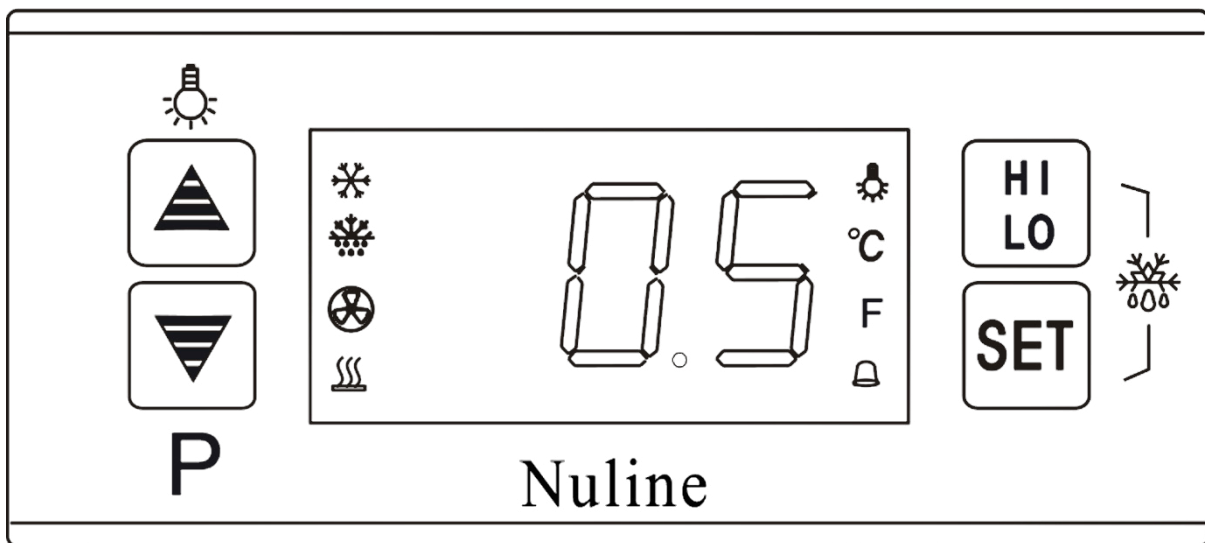

Initial Start-Up & Operation

	IMPORTANT
	This unit is only designed to maintain the product at the controlled 2°C to 8°C temperature.

Controller









Key Functions:

	To see the target set point; to confirm an operation, to exit the adjustment state
	To cycle through the parameters; to turn on / off the light
	To cycle through the parameters; to display the product sensor temperature; to silence the alarm.
	To view the highest temperature and the lowest temperature; to clear the recent high and low temperature recording

OPERATION

LED Indications:

Refrigeration LED	
	The LED is on during refrigeration.
	The LED is off when the temperature is constant.
	The LED flashes during the delay
Defrost LED	
	The LED is on during defrosting
	The LED flashes during the delay display after defrosting
Other LED	
	The LED is on when the interior lights are on
	The LED is on when the temperature is displayed in Celsius

Initial Start Up

- Before switching ON the cabinet, ensure the cabinet is installed correctly.
- Plug the cabinet into your 10amp GPO 240-volt outlet and switch ON, check that the air is flowing within the unit.
- After 45 minutes check the cabinet temperature has reached it's set temperature. The temperature alarm will sound during the initial start-up, this is normal, you can push any button to silence the alarm during this initial set up.
- Leave the unit to operate for 1 – 2 hours to cycle numerous times.
- Clean the whole unit, including the shelves, before placing in product.
- Air vents must NOT be covered.

OPERATION

Cabinet Temperature

- Ensure the cabinet is maintaining temperature between its temperature range.
- Ensure the doors are CLOSED when not loading to maintain temperature.
- Cabinet temperature will vary when the motor stops and starts. This is only air temperature and not product temperature.
- Temperature reading should only be done as follows, reset controller at end of day and do not open door again, next morning take your high and low read out before you open door.

How to Check Min / Max Temp

- Press  button and your max temperature will appear while flashing.
- Repeat process to obtain min temperature.

To RESET min/max temperature

Press  button, hold for 6-10 seconds, the temperature will flash and display for 3 seconds and the buzzer sounds.

Product sensor

Your refrigerator has been fitted with a product sensor inserted into an aluminium block, this represents product temperature.

To see what temperature the product is press  button and temperature will flash and display, the cabinet temperature will display after 6 seconds.

OPERATION

Refrigerator Defrost Cycle – Automatic

The controller automatically controls the cyclic defrosting of the cabinet. There's no need to do anything.

Alarm

To silence alarm, press any button.

Alarm Set Points

Low Alarm +2 °C
High alarm +8 °C
Delay on alarm is 10 minutes
Temperature Set Point is 4.5°C

H1 will be displayed, and the high temperature alarm will be active when the cabinet temperature is above the set temperature.

H2 and cabinet temperature will be displayed, and the high temperature alarm will be active when the product temperature is equal to or above the set temperature.

MAINTENANCE

Cleaning



WARNING

Never disassemble, repair, or modify the cabinet yourself. Any such work carried out by an unauthorized person may result in fire, or electric shock or injury due to a malfunction.

General Information

- Cleaning is recommended for health and safety purposes and to prolong the life of the cabinet.
- **DO NOT** use abrasive pads or cleaners on the stainless steel or any other metal parts of the cabinet.
- **DO NOT** use industrial chemical cleaners, flammable cleaners, caustic-based cleaners or bleaches and bleaching agents, as many will damage the metals and plastics used on this cabinet.
- **DO NOT** remove any screws and / or panels for cleaning (unless directed)
- This unit is **NOT** waterproof, **DO NOT** hose, **DO NOT** pour water directly onto the unit, **DO NOT** immerse in water.
- Before performing maintenance or cleaning the unit, disconnect the electrical power supply.

Corrosion Protection

- Stainless steel exhibits good resistance to corrosion however, if not properly maintained stainless steel can rust and / or corrode.
- Any sign of mild rust and / or corrosion should be thoroughly cleaned with warm soapy water and dried as soon as possible.
- NEVER use abrasive pads or cleaners for cleaning
- All metal surfaces should be checked while cleaning for damage, scuffs or scrapes as these can lead to rust and further damage to the cabinet.
- Mild rust and / or corrosion can be treated with a commercial cleaning agent that contains citric

MAINTENANCE

/ oxalic / nitric / phosphoric acid. **DO NOT** use cleaning agents with chlorides or other harsh chemicals as this can cause corrosion. After treatment, wash with warm (not hot) soapy water and dry thoroughly.

- Thoroughly wipe the surfaces dry after cleaning. **DO NOT** let water pool on the unit. Check crevices and folds for pooling.
- When using, ensure all liquids and moisture is cleaned up straight away.
- **DO NOT** leave items on the stainless steel.

Surface Finish

- To protect the polished surface of the stainless steel, it should be dried using a clean dry soft cloth.
- Some commercial stainless-steel cleaners can leave residue or film on the metal; this may trap fine particles from the air on the surface, thus deeming the surface not safe for medical products.



WARNING

This unit is NOT waterproof, DO NOT hose. DO NOT pour water directly onto the unit. DO NOT immerse in water



CAUTION

This unit includes refrigeration components. DO NOT touch the cold refrigeration components

MAINTENANCE

Cleaning Schedule

Regular cleaning, at least once a month is recommended for the cabinet. This will help to maintain and prolong the efficiency of the cabinet.

Always keep the interior free of ice. A soft cloth or brush can be used to remove loose ice. Never use sharp tools and take care not to damage the door gaskets.

Wipe down all interior and exterior surfaces with a soft, dry cloth or a soft cloth dampened with warm soapy water. Wipe dry with a dry soft cloth to ensure that there's no water remaining on the cabinet.

If a thorough cleaning or disinfection is required, please follow the instructions below.

Cabinet Interior

1. Isolate the unit from the power supply.
2. Remove shelves and wash separately, thoroughly wipe dry after cleaning.
3. Using a good quality nylon brush remove any small particles.
4. Clean using a clean cloth dampened with clean warm soapy water until all soil has been removed.
5. Thoroughly wipe dry with a soft cloth after cleaning, do NOT allow to air dry. DO NOT let water to pool, check crevices and folds.

Door Seal

- Using a clean cloth dampened with warm water, wipe down the door seal.

Glass Door

1. Clean the glass with a glass cleaner or warm soapy water, and a sponge.
2. Using a squeegee, remove all water from the glass.
3. External Surfaces
4. Using a clean cloth dampened with clean warm soapy water unit any grime has been removed.
5. Using a clean sanitised cloth, thoroughly wipe the stainless steel and metal parts dry. Do NOT let water to pool on the cabinet. Check crevices and folds.

MAINTENANCE

Ventilation Panels / Filter

- Use a vacuum and / or brush to remove dust and debris from the filter and all ventilation panels.
- Do NOT use water or a hose to remove dust or debris.

Condenser

It is important to periodically clean the condenser, which is located on back of cabinet. It should be cleaned every 3 months, simply by brushing in a vertical motion with a small brush or vacuum cleaner.





However, this will also depend on how dusty the area is. You may be able to do it every 6 months.

MAINTENANCE

Temperature Adjustment

Temperature Controller Parameters

The temperature parameters of the cabinet should only be programmed or modified by personnel who know the cabinet, its operation, and the possibilities of the cabinet where applicable.

1. Press the  button and hold for 6 seconds to enter the parameter settings, PAS will be displayed flashing, once the correct password is entered press  (default password is 15) and "E1, E2, E3, ..., PAS." will display in sequence.
2. Using the  or  to display and modify the value of the parameter. Press  to confirm. If no more buttons are pressed within 6 seconds, it will exit.

Note: Parameters can only be adjusted once the correct password has been entered. If the incorrect password is entered, the parameter modification will exit, the set temperature adjustment still active. If the password is forgotten, it will need to be resumed to the factory defaults.

To Change the Parameter Password

After entering the parameter settings, use the  or  buttons to display and change the password, then press  button to confirm and store the new password.

MAINTENANCE

Parameter Table

Parameter	Function	Set Range	Default	Parameter	Function	Set Range	Default
PAS	Password	00-99	15	C5	Starting up temp. Alarm delay	00-99 min	10 min
E1	Lower set point limit	-30°C – Set temp.	2.0°C	C6	Temp. Alarm delay	00-99 min	10 min
E2	Higher set point limit	30.0°C -Set temp.	10.0°C	C7	Power off relay alarm	00 = do not alarm 01 = alarm	01
E3	Temp. Hysteresis	0.1-20.0°C	0.4°C	C8	Alarm relay close after muffle, alarm relay switch	00 = open 01 = close	00
E40	Turning on delay time	00-10 min	3 min	C9	Restart time after buzzer mute	00 – do not restart 01-30 min = restart time	10 min
E41	Comp. Start delay time	00-10 min	3 min	C10	Comp. Force stop time	01-99 min	99 min
E5	Offset on room temp.	-30 – 30.0°C	0.0°C	C11	Comp. Force running time	00 = comp. Stop 01-99 min = starting time	0 min
E6	Offset on evap. Temp	-30 – 30.0°C	0.0°C	C12	Alarm output type	00 =contact actuation when alarm 01 – contact disconnect when alarm	01
F0	Defrost type	00 = defrost by turning off comp.	00	CF	Temperature unit	°C=Celsius	°C
F1	Max defrosts duration	01-60 min	1 min	Do1	Door open alarm	00 = do not alarm 01-99 min = delay alarm	00 min
F2	Defrost internal time	00-24 Hr	00	Do2	Comp. State when door open	00 = stop 01 = original status	01
F4	Display during defrostt	00 = cabinet temperature display normally 01 = last value before defrost 02 = fixed display cold room temp 03 = display DEF	00	Do3	Light state when door open	00 = start 01 - original status	01
C1	Cabinet high temp. alarm	Set temp. – 30.0°C	8.0°C				
C2	Cabinet low temp. alarm	-30°C – set temp	2.0°C				
C3	Product temp. High temp. Alarm	-30 to 30.0°C	20.0°C				
C4	Alarm hysteresis	1.0 – 20.0°C	2.0°C				

MAINTENANCE

Inactivity for Extended Period

Please take the following precautions when storing the cabinet for an extended period of time.

1. Clean both the interior and exterior of the cabinet
2. Ensure that the cabinet is completely dry.
3. Disconnect the power cord.
4. To prevent any rot and mould from forming, leave the door slightly ajar to allow air flow.

MAINTENANCE

Disposal

If the cabinet is no longer of use, please dispose in an environmentally correct way.

- Contact a qualified service technician to recover all refrigerant and to remove the compressor or remove the oil from the compressor.
- The distributor / retailer can contact their local metal recycling centre to collect the remaining cabinet, shelves, etc.
- There may be special requirements or conditions. Information on the disposal of refrigeration appliances can be obtained from government authorities, (the local council, Ministry of the Environment, etc.)
- Discarded electric appliances are recyclable and should not be discarded in the domestic waste. Please actively support us in conserving resources and protecting the environment by returning this appliance to the collection centres (if available).
- Dispose of packaging in accordance with applicable legal regulations.